

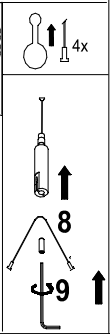

ART	A(mm)	B(mm)	C1(mm)	C2(mm)	X(mm)	Y(mm)	R(mm)	B	R1(mm)	A	S(mm)
ART	1210	200	22	37	440	45	1030		440		100

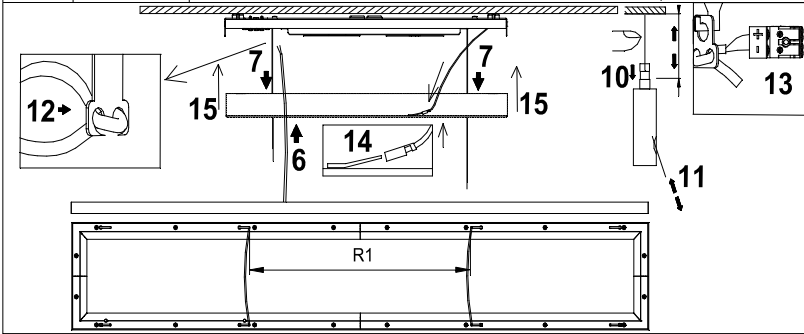

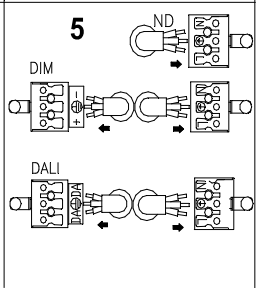
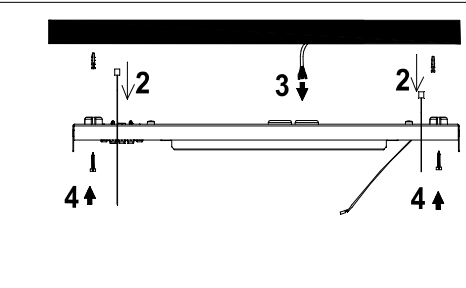
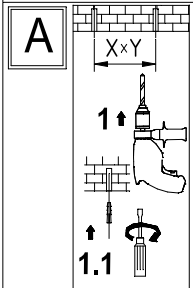
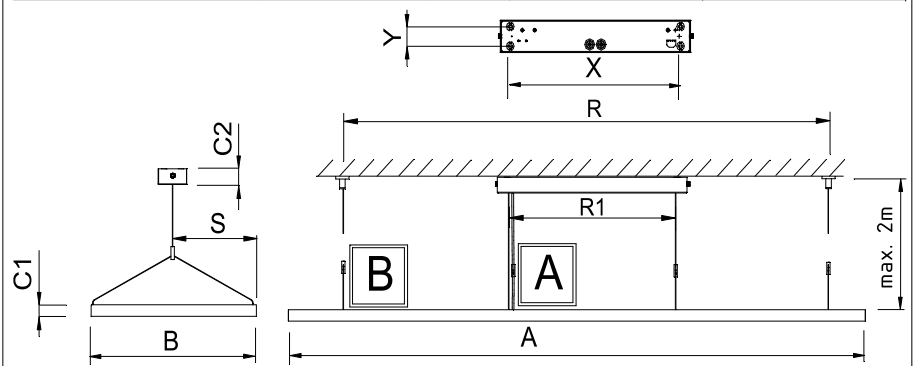
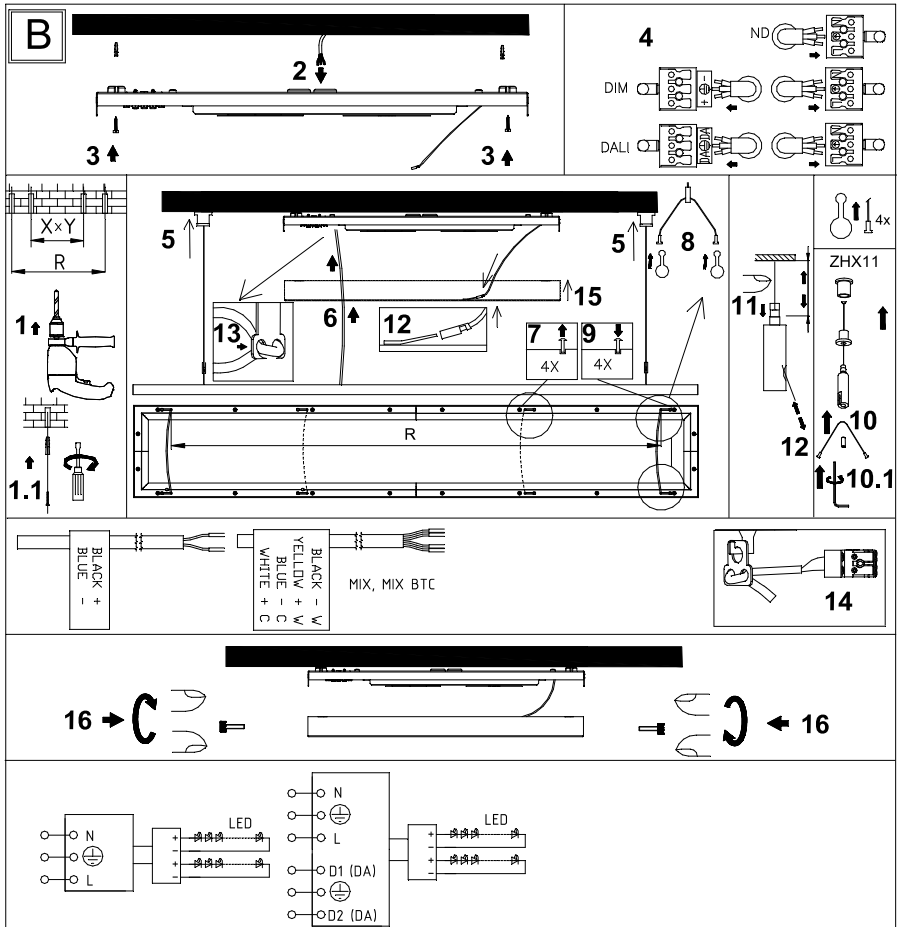

Attention! The lighting unit may only be assembled by a skilled firm or by person with electrotechnical qualification. The light source of this luminaire is not replaceable, when the light source reaches its end of life the whole luminaire should be replaced.