

LORD 4

Riflettore industriale e commerciale a sospensione. Corpo in alluminio pressofuso verniciato con polvere termoidurente poliesteri anticorrosione colore silver o antracite, vetro temperato trasparente spessore 4 mm, guarnizione in silicone, driver elettronico 220-240V 50/60Hz. Prodotto in conformità alle vigenti norme EN / IEC 60598-1:2018.

Industrial and commercial suspended high-bay. Die cast aluminium body, coated with polyester anticorrosion powder silver or anthracite color, 4 mm thick tempered transparent glass, silicon gasket, electronic driver 220-240V 50/60Hz. Manufactured in accordance with EN / IEC 60598-1:2018.



INSTALLAZIONE / INSTALLATION



CARATTERISTICHE / MAIN FEATURES

LED | CE | 220-240 V_~ | -25°C / +45°C | IP65 | IK08 | RG0 | CRI >80 | 3 step MacAdam | <7% LOW flicker | L80-B20 >50.000h | L80-B50 >75.000h | A++

CODIFICA - colore silver / CODING - silver color

Art.	+	Mod.	+ °K (CRI)	+	W. tot.	+ Options	RAL 9006
8032		SU	3 = 3000°K (CRI >80)		150	GL = on/off	
		S2	4 = 4000°K (CRI >80)		175	GM = 1-10v	
		S5	5 = 5000°K (CRI >80)		200	GD = dali	
		CU	6 = 6500°K (CRI >80)		230	G1 = em. 1h	
		EL			240	G3 = em. 3h	
					280	GA = vetro acidato / acid-etched glass	
						GV = vetro infrangibile / shatterproof glass	
						SG = multisensor DALI	

CODIFICA - colore antracite / CODING - anthracite color

Art.	+	Mod.	+ °K (CRI)	+	W. tot.	+ Options	RAL 7015
8032		SU	3 = 3000°K (CRI >80)		150	EL = on/off	
		S2	4 = 4000°K (CRI >80)		175	LM = 1-10v	
		S5	5 = 5000°K (CRI >80)		200	LD = dali	
		CU	6 = 6500°K (CRI >80)		230	E1 = em. 1h	
		EL			240	E3 = em. 3h	
					280	VA = vetro acidato / acid-etched glass	
						VI = vetro infrangibile / shatterproof glass	
						SE = multisensor DALI	



Δ LUMEN

3000°K (CRI >80) = **-5.28%**
 4000°K (CRI >80) = **standard**
 5000°K (CRI >80) = **+0.90%**
 6500°K (CRI >80) = **+3.00%**



INSTALLAZIONE / INSTALLATION

Installazione a plafone
Surface mounting installation

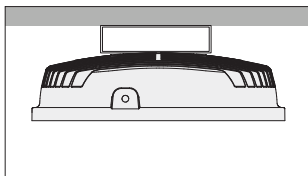

Apparecchio adatto per installazione a plafone. (ACC058-059)

Surface mounting installation. (ACC058-59)

Installazione a sospensione
Suspended installation

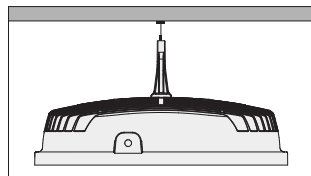

Apparecchio adatto per installazione a sospensione.

Suspended installation.

Installazione a blindosbarra
Busbar installation

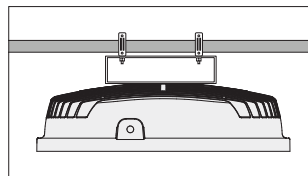

Apparecchio adatto per installazione a blindosbarra. (ACC060-061)

Busbar installation. (ACC060-61)

DIMENSIONI / DIMENSIONS

	A	B	C	Kg	mc	
D1	375	375	230	9,0	0,024	50
D2	375	375	250	9,7	0,026	50

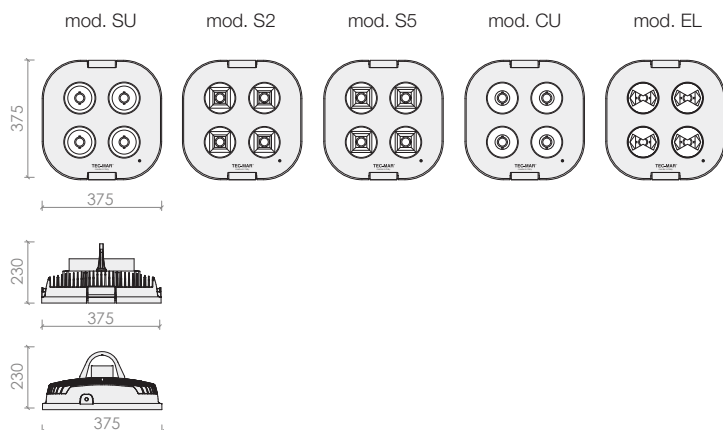

Mod. SU

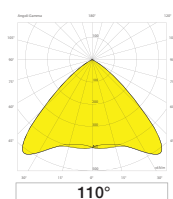
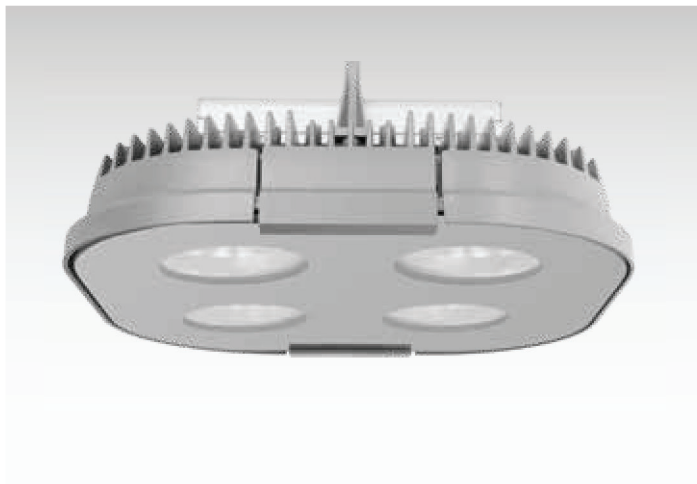

Ottica

Riflettore simmetrico 110° in alluminio satinato.

Optic

110° wide beam matt satin aluminium reflector

Dotazione

Sistema di fissaggio a sospensione incluso.
Cablaggio esterno tramite connettore rapido IP66.

Equipment

Suspension mounting system included. External wiring via IP66 rapid connector.

W tot.	n° Led	Lm LED*	Lm OUTPUT	Lm/W	replace	dimension
150	4	28405	20900	139	250W JM/SAP	D1
175	4	31898	24711	141	250W JM/SAP	D1
200	4	35331	27370	137	400W JM/SAP	D1
230	4	39687	30733	134	400W JM/SAP	D1
240	4	41454	32101	134	400W JM/SAP	D2
280	4	46686	36152	129	600W SAP	D2

*4000K CRI>80

Mod. S2

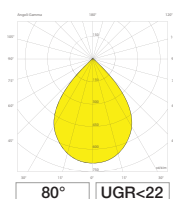
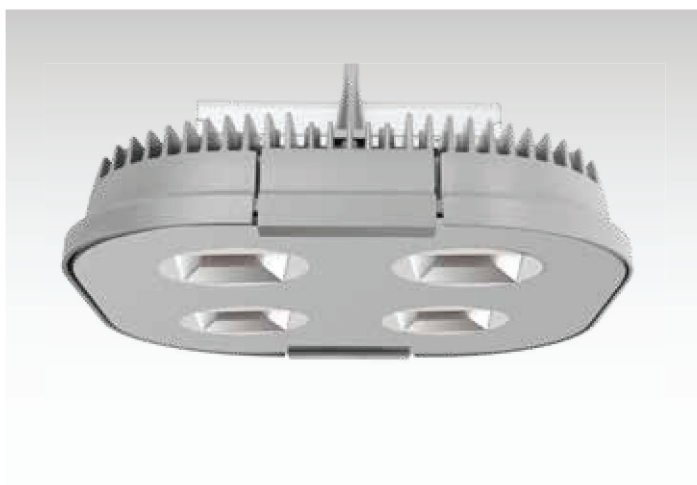

Ottica

Riflettore simmetrico 80° in alluminio satinato

Optic

80° medium beam matt satin aluminium reflector

Dotazione

Sistema di fissaggio a sospensione incluso.
Cablaggio esterno tramite connettore rapido IP66.

Equipment

Suspension mounting system included. External wiring via IP66 rapid connector.

W tot.	n° Led	Lm LED*	Lm OUTPUT	Lm/W	replace	dimension
150	4	28405	20518	137	250W JM/SAP	D1
175	4	31898	24259	139	250W JM/SAP	D1
200	4	35331	26870	134	400W JM/SAP	D1
230	4	39687	30171	131	400W JM/SAP	D1
240	4	41454	31514	131	400W JM/SAP	D2
280	4	46686	35491	127	600W SAP	D2

*4000K CRI>80

Mod. S5

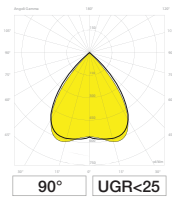

Ottica

Riflettore simmetrico 90° in alluminio satinato.

Optic

90° wide beam matt satin aluminium reflector



Dotazione

Sistema di fissaggio a sospensione incluso.
Cablaggio esterno tramite connettore rapido IP66.

Equipment

Suspension mounting system included. External wiring via IP66 rapid connector.

W tot.	n° Led	Lm LED*	Lm OUTPUT	Lm/W	replace	dimension
150	4	28405	21410	143	250W JM/SAP	D1
175	4	31898	25314	145	250W JM/SAP	D1
200	4	35331	28038	140	400W JM/SAP	D1
230	4	39687	31483	137	400W JM/SAP	D1
240	4	41454	32884	137	400W JM/SAP	D2
280	4	46686	37034	132	600W SAP	D2

*4000K CRI>80

Mod. CU

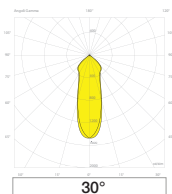
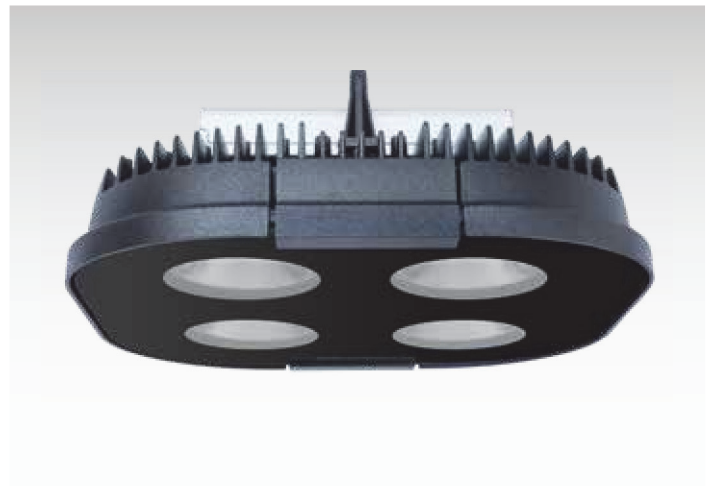

Ottica

Riflettore concentrante 30° in alluminio satinato

Optic

30° narrow beam matt satin aluminium reflector



Dotazione

Sistema di fissaggio a sospensione incluso.
Cablaggio esterno tramite connettore rapido IP66.

Equipment

Suspension mounting system included. External wiring via IP66 rapid connector.

W tot.	n° Led	Lm LED*	Lm OUTPUT	Lm/W	replace	dimension
150	4	28405	20773	138	250W JM/SAP	D1
175	4	31898	24560	140	250W JM/SAP	D1
200	4	35331	27203	136	400W JM/SAP	D1
230	4	39687	30546	133	400W JM/SAP	D1
240	4	41454	31905	133	400W JM/SAP	D2
280	4	46686	35932	128	600W SAP	D2

*4000K CRI>80

Mod. EL

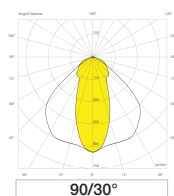
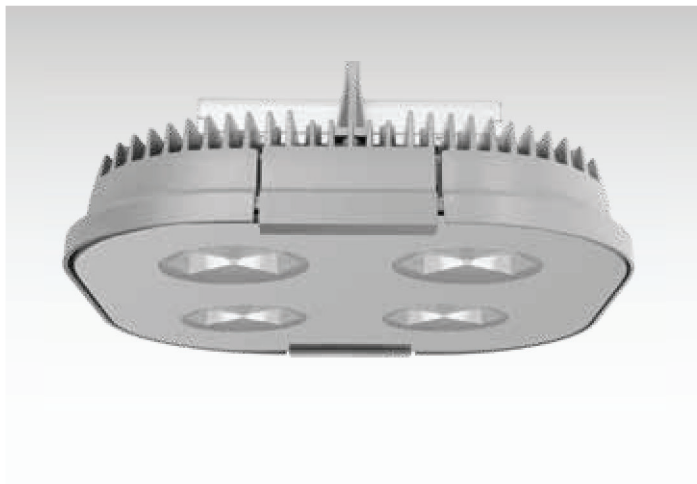

Ottica

Riflettore ellittico in alluminio satinato

Optic

Elliptical matt satin aluminium reflector

W tot.	n° Led	Lm LED*	Lm OUTPUT	Lm/W	replace	dimension
150	4	28405	20582	137	250W JM/SAP	D1
175	4	31898	24334	139	250W JM/SAP	D1
200	4	35331	26953	135	400W JM/SAP	D1
230	4	39687	30265	132	400W JM/SAP	D1
240	4	41454	31612	132	400W JM/SAP	D2
280	4	46686	35601	127	600W SAP	D2

Dotazione

Sistema di fissaggio a sospensione incluso.
Cablaggio esterno tramite connettore rapido IP66.

*4000K CRI>80

Equipment

Suspension mounting system included. External wiring via IP66 rapid connector.

ILLUMINAZIONE DI CORSIE / LANES LIGHTING

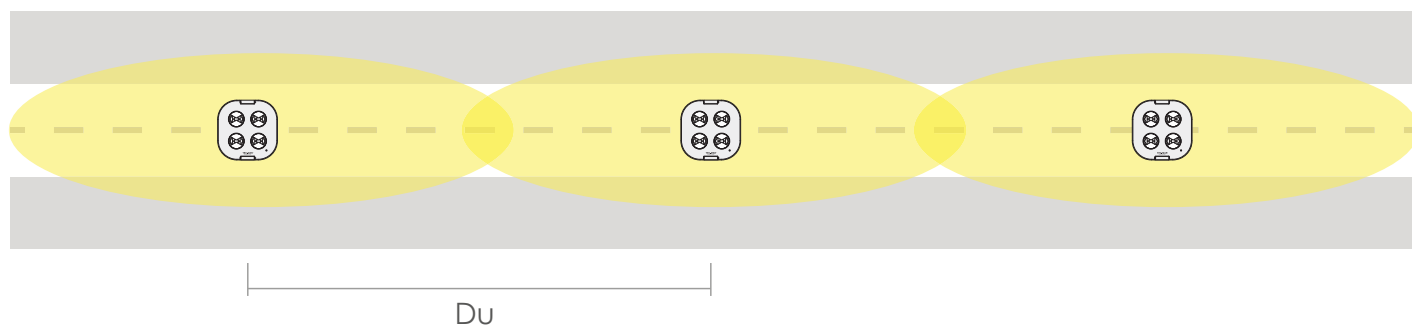

Uniformità

il passo di installazione per ottenere l'uniformità di illuminamento con 150 lux:

$$DU = 1,35 \times hu$$

hu = altezza utile di installazione

Uniformity

Installation distance to achieve sufficient uniformity with 150 lux:

$$DU = 1,35 \times hu$$

hu = usefull height of installation



- ACC058** Kit staffe per installazione a plafone (silver RAL 9006)
Surface mounting kit (silver RAL 9006)
- ACC059** Kit staffe per installazione a plafone (antracite RAL 7015)
Surface mounting kit (anthracite RAL 7015)
- ACC060** Kit staffe per installazione a blindo sbarra (silver RAL 9006)
Busbar mounting kit (silver RAL 9006)
- ACC061** Kit staffe per installazione a blindo sbarra (antracite RAL 7015)
Busbar mounting kit (anthracite RAL 7015)
- ACC031** Griglia di protezione 385 x 385 mm
385 x 385 mm protection grid
- ACC019** Sensore per apparecchi industriali DALI
Sensor for DALI industrial fixtures
- ACC036** Telecomando per sensori industriali (opzionale)
Remote control for industrial sensors (optional)
- ACC068** Connettore stagno IP66 per connessione 2P+E (16A - 400V). Colore grigio.
IP66 waterproof connector, 2P + E (16A - 400V). Color: grey.
- ACC069** Connettore stagno IP66 per connessione 2P+E (16A - 400V). Colore nero.
IP66 waterproof connector, 2P + E (16A - 400V). Color: black.
- ACC070** Connettore stagno IP66 per connessione 4P+E (16A - 400V). Colore grigio.
IP66 waterproof connector, 4P + E (16A - 400V). Color: grey.
- ACC071** Connettore stagno IP66 per connessione 4P+E (16A - 400V). Colore nero.
IP66 waterproof connector, 4P + E (16A - 400V). Color: black.
- ACC117** Kit staffe regolabili (silver RAL 9006)
Adjustable brackets kit (silver RAL 9006)
- ACC118** Kit staffe regolabili (antracite RAL 7015)
Adjustable brackets kit (anthracite RAL 7015)
- ACC132** Multisensore di luminosità e movimeto IP65 wireless 868 MHz per apparecchi DALI per altezze fino a 17m. (Regola fino a 32 apparecchi con ACC134).
Brightness and movement wireless multi sensor 868 MHz for DALI fixture IP65 for heights up to 10m. (Up to 32 fixtures with ACC134).
- ACC133** Multisensore di luminosità e movimeto IP65 wireless 868 MHz per apparecchi DALI per altezze fino a 10m. (Regola fino a 32 apparecchi con ACC134).
Brightness and movement wireless multi sensor 868 MHz for DALI fixture IP65 for heights up to 10m. (Up to 32 fixtures with ACC134).
- ACC134** Nodo IP65 per controllo wireless 868MHz di apparecchi DALI IP65. (da accoppiare con ACC132 o ACC133). Da installare su singolo apparecchio.
Node for 868MHz wireless control of DALI fixture IP65. (with ACC132 or ACC133). Installed on single fixture.
- ACC135** Gateway portatile per la configurazione dei dispositivi wireless 868 MHz.
Gateway for wireless sensor configuration 868 MHz.

APPLICAZIONI / APPLICATION

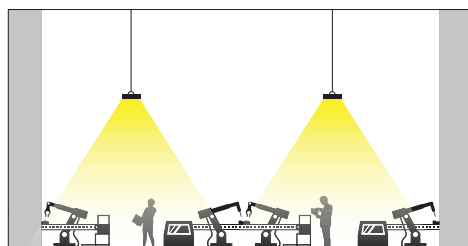

Utilizzo dell'ottica diffondente per l'illuminazione un'area di lavoro con installazione tra i 5 e i 9 metri.

Wide beam fixture used in a large work area with height from 5 to 9 meters.

Mod. SU

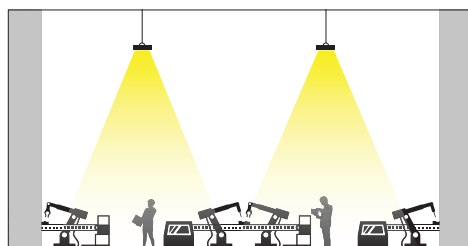
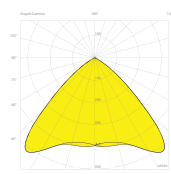

Utilizzo dell'ottica media per l'illuminazione un'area di lavoro con installazione elevata.

Medium beam fixture used in a large work area with high height.

Mod. S2

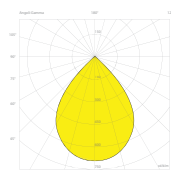

Mod. S5

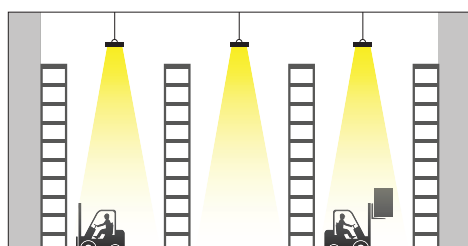
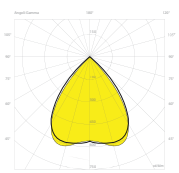

Utilizzo di un ottica ellittica per l'illuminazione di corsie per garantire un'illuminazione corretta senza dispersione di luce.

Elliptical beam fixture to avoid light dispersion within lanes installation.

Mod. EL

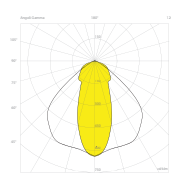

Mod. CU

