



Technical features



Technical data

IP Rating	IP65
IK Rating	IK08
Material	High corrosion resistance die-cast copper-free aluminum body
Coating	Polyester powder coating with phosphochromating pre-finish
Screws	Stainless steel
Light source	NR. 12 -> 24 x 1.5W CREE "XP-G3" LED
Gasket	Silicone rubber
Glass	Tempered
Transformer	Electronic transformer 220/240V 50/60Hz included
Cable gland	Double nickel-plated brass cable gland PG9
Power cable	3 m neoprene power cable included
Weight	3,00 Kg

803001 - 803002

SINGLE BOOK POLE TOP MAXI

Square pole-top mounted floodlight for outdoor installation on a pole diam. 60 mm or 76 mm. Phospho-chromatised and polyester powder coated die-cast copper-free aluminium body, tempered safety glass, moulded silicone gasket and stainless steel screws. Flange for pole diam. 60 mm or 76 mm included. Built-in LED driver 220-240V 50-60Hz, with 12 or 24 CREE XP-G3 LED. IP65 rating.

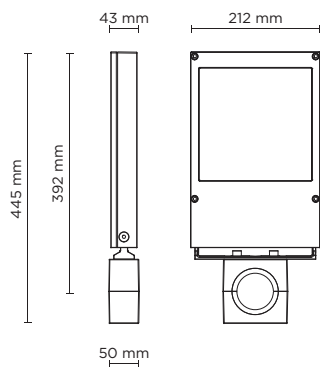



CYCLE ROUTE / PEDESTRIAN



STREET



803001	SINGLE BOOK POLE - TOP MAXI 12 LED 18 WATT 220-240V 50-60HZ ELECTRONIC
--------	----------------------------------------------------------------------------------

light source*	light beam options	lumen output (lm)	lumin. efficacy (lm/w)
3000°K warm-white			
high power led	 cycle route pedestrian	1.728	96.00
high power led	 street	1.728	96.00



* Other light colors available on request: Neutral-white

Colors options

 Textured Grey RAL 9006	 Anthracite Grey RAL 7016	 Matt Black (on request)
-------------------------------------------------------------------------------------------------------------	---------------------------------------------------------------------------------------------------------------	--------------------------------------------------------------------------------------------------------------



803002	SINGLE BOOK POLE - TOP MAXI 24 LED 36 WATT 220-240V 50-60HZ ELECTRONIC
--------	----------------------------------------------------------------------------------

light source*	light beam options	lumen output (lm)	lumin. efficacy (lm/w)
3000°K warm-white			
high power led	 cycle route pedestrian	3.456	96.00
high power led	 street	3.456	96.00

* Other light colors available on request: Neutral-white

Colors options

 Textured Grey RAL 9006	 Anthracite Grey RAL 7016	 Matt Black (on request)
-------------------------------------------------------------------------------------------------------------	---------------------------------------------------------------------------------------------------------------	--------------------------------------------------------------------------------------------------------------



POLES & ACCESSORIES

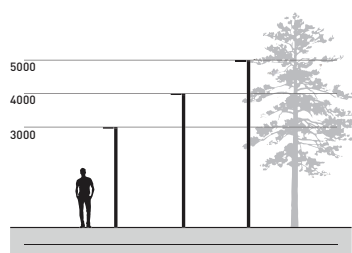

BURIED POLES			
code	article	h. mm.	description
809901	cylindrical pole 3,5 meters to be buried	3.500	Cylindrical pole made in steel S235JR (UNI EN 10219) hot galvanized (UNI EN 1461), diameter 76 mm, thickness 4 mm.
809902	cylindrical pole 4,5 meters to be buried	4.500	Phospho-chromatised and polyester powder coated. Total height including 500 mm to be buried into the ground. Includes IP54 cover plate 132x38 mm and terminal block in double insulation.
809903	cylindrical pole 5,5 meters to be buried	5.500	Phospho-chromatised and polyester powder coated. Total height including 500 mm to be buried into the ground. Includes IP54 cover plate 132x38 mm and terminal block in double insulation.
809909	Top cap for pole diam. 76 mm.		

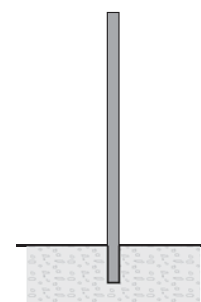

POLES WITH BASE-PLATE			
code	article	h. mm.	description
809904	cylindrical pole 3 meters with base-plate	3.000	Cylindrical pole made in steel S235JR (UNI EN 10219) hot galvanized (UNI EN 1461), diameter 76 mm, thickness 4 mm.
809905	cylindrical pole 4 meters with base-plate	4.000	Phospho-chromatised and polyester powder coated. With base plate dim. 250x250 mm, thickness 10 mm Includes IP54 cover plate 132x38 mm and terminal block in double insulation.
809906	cylindrical pole 5 meters with base-plate	5.000	Phospho-chromatised and polyester powder coated. With base plate dim. 250x250 mm, thickness 10 mm Includes IP54 cover plate 132x38 mm and terminal block in double insulation.
809907	anchorage unit for base-plate		Base plate dim. 250x250 mm, thickness 3 mm, made in galvanized steel complete of nr. 4 anchorage threaded bolts
809909	Top cap for pole diam. 76 mm.		

