

LUDO LINEAR DK

// Istruzioni per il montaggio // Assembly instructions

CE

A++

 5 years warranty

 Direct Emission

 UGR < 16

 IP 40

 3000K/4000K

 >96 lm/W

 CRI >90+

 Eye safety: RG0/RG1

 Mac Adams 3

 L80/B10 >50.000h

// **Avvertenze.** La sicurezza dell'apparecchio è garantita solamente con l'uso appropriato delle presenti istruzioni che devono essere lette e conservate. • Togliere tensione di rete prima della sostituzione delle lampade e comunque prima di ogni operazione di manutenzione. • Non coprire l'apparecchio con panni o con quant'altro possa causare un eccessivo surriscaldamento. • La nostra azienda declina ogni responsabilità per danni causati da uno scorretto utilizzo o dalla manomissione dell'apparecchio stesso. • Per la sostituzione di componenti usurati rivolgersi a personale qualificato. • L'apparecchio non deve essere smaltito come rifiuto urbano. Deve essere soggetto a raccolta separata per evitare danni all'ambiente nel rispetto della direttiva 2002/96 e delle leggi nazionali per lo smaltimento del prodotto a fine vita. Il mancato rispetto di quanto sopra è sanzionato dalla Legge. • Si prega di informarsi in merito al sistema locale di raccolta differenziata per i prodotti elettrici ed elettronici.

// **Warning.** The safety of the fixture is guaranteed only under the correct use of the present instructions, which have to be read and kept. • Turn off the net voltage before the replacement of the lamp and however before any maintenance action. • Do not cover the fixture with clothes or something else which could cause an excessive overheating. • Our company declines all responsibility for damages caused by an incorrect use or by the tampering of fixture itself. • For replacement of worn out components please address to the skilled staff. • The fixture could not be disposed as urban waste. It must be subject o separate waste collection to avoid environmental damage in compliance with directive 2002/96 and national laws for the disposal of product at the end of its working life. The non-compliance of the above mentioned directive will be sanctioned by Law. • We ask you to kindly get information about local separate waste collection system for electric and electronic products.

ISLUK



Attenzione: prima di procedere con ciascuna delle seguenti operazioni, togliere la tensione di rete

Attention: before proceeding with each of the following operations, switch off the power supply

esse-ci
LIVING LIGHT

Esse-Ci Srl
Viale del Lavoro 25, 35010 Vigonza (PD) Italy
Tel. +39 049 8959511
info@esse-ci.it
www.esse-ci.it

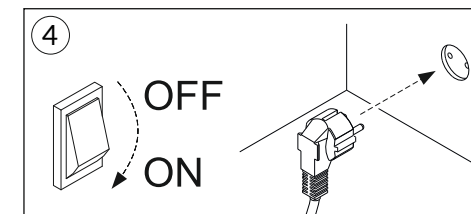
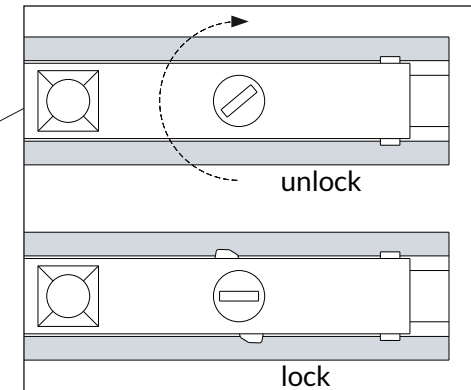
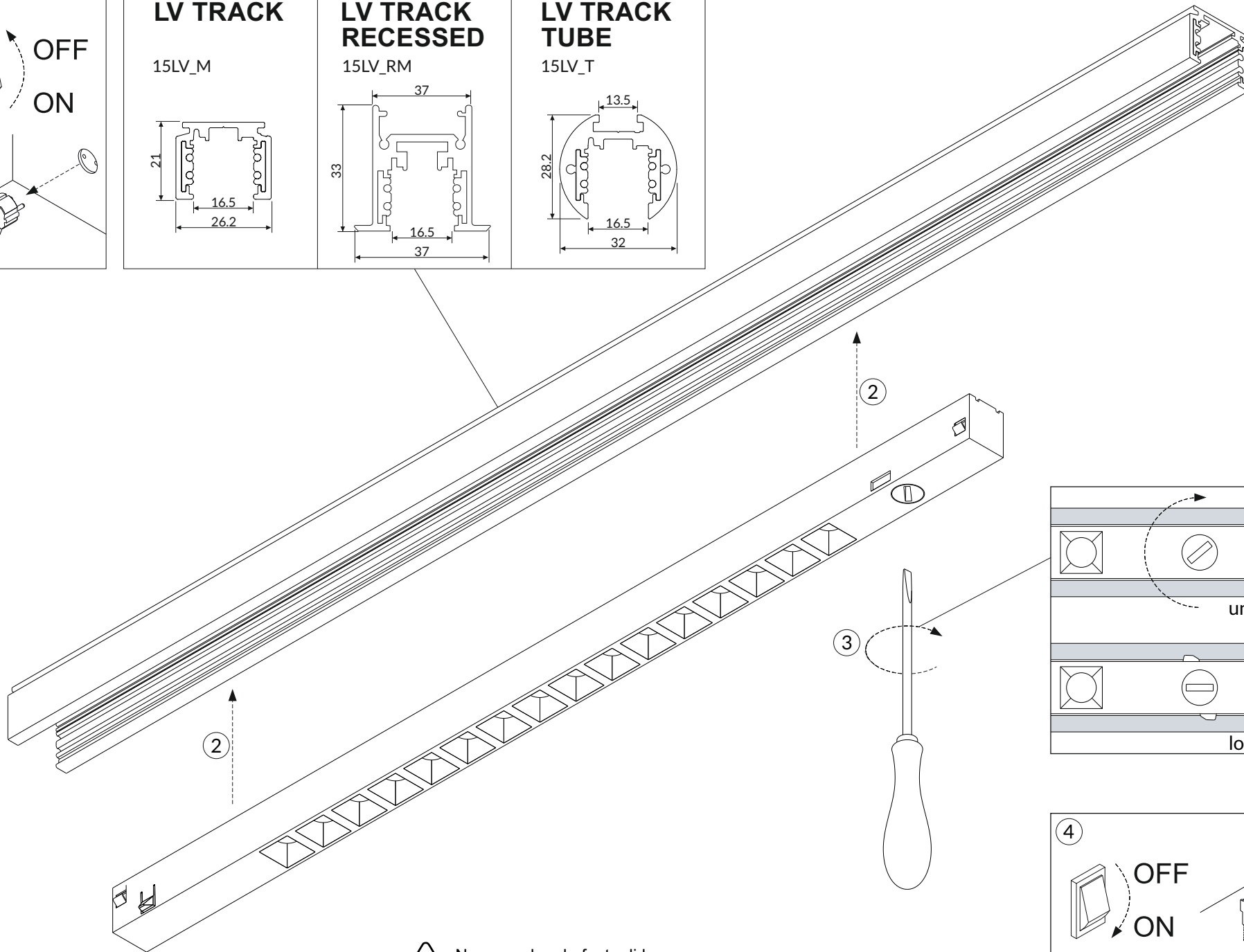
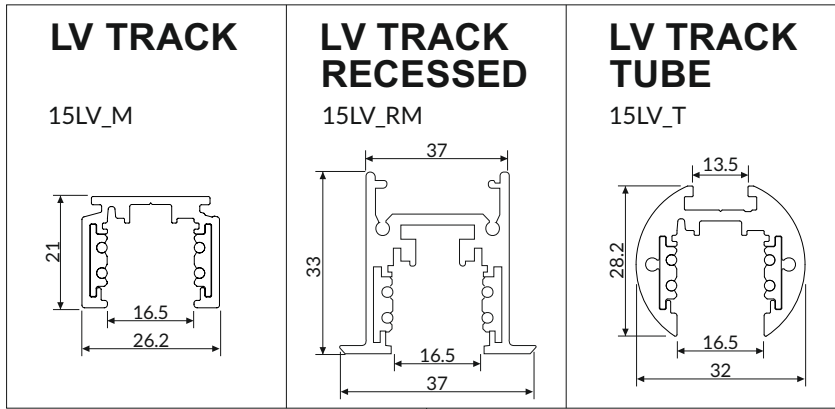
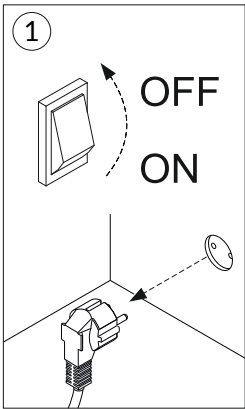

Non guardare la fonte di luce
Do not stare at the operating light source